

# IRG4PH40UDPbF

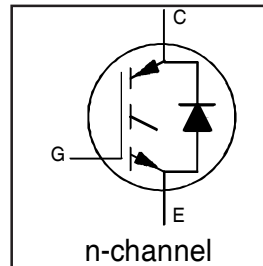
INSULATED GATE BIPOLAR TRANSISTOR WITH ULTRAFAST SOFT RECOVERY DIODE      UltraFast CoPack IGBT

## Features

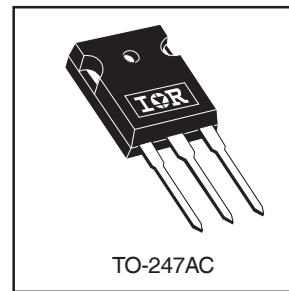
- UltraFast: Optimized for high operating frequencies up to 40 kHz in hard switching, >200 kHz in resonant mode
- New IGBT design provides tighter parameter distribution and higher efficiency than previous generations
- IGBT co-packaged with HEXFRED™ ultrafast, ultra-soft-recovery anti-parallel diodes for use in bridge configurations
- Industry standard TO-247AC package
- Lead-Free

## Benefits

- Higher switching frequency capability than competitive IGBTs
- Highest efficiency available
- HEXFRED diodes optimized for performance with IGBT's. Minimized recovery characteristics require less/no snubbing



$V_{CES} = 1200V$
$V_{CE(on)} \text{ typ.} = 2.43V$
@ $V_{GE} = 15V, I_C = 21A$



## Absolute Maximum Ratings

	Parameter	Max.	Units
$V_{CES}$	Collector-to-Emitter Breakdown Voltage	1200	V
$I_C @ T_C = 25^\circ C$	Continuous Collector Current	41	A
$I_C @ T_C = 100^\circ C$	Continuous Collector Current	21	
$I_{CM}$	Pulsed Collector Current ①	82	
$I_{LM}$	Clamped Inductive Load Current ②	82	
$I_F @ T_C = 100^\circ C$	Diode Continuous Forward Current	8.0	
$I_{FM}$	Diode Maximum Forward Current	130	
$V_{GE}$	Gate-to-Emitter Voltage	$\pm 20$	V
$P_D @ T_C = 25^\circ C$	Maximum Power Dissipation	160	W
$P_D @ T_C = 100^\circ C$	Maximum Power Dissipation	65	
$T_J$	Operating Junction and Storage Temperature Range	-55 to + 150	$^\circ C$
$T_{STG}$			
	Mounting torque, 6-32 or M3 screw.	10 lbf•in (1.1N•m)	

## Thermal Resistance

	Parameter	Min.	Typ.	Max.	Units
$R_{\theta JC}$	Junction-to-Case - IGBT	---	---	0.77	$^\circ C/W$
$R_{\theta JC}$	Junction-to-Case - Diode	---	---	1.7	
$R_{\theta CS}$	Case-to-Sink, flat, greased surface	---	0.24	---	
$R_{\theta JA}$	Junction-to-Ambient, typical socket mount	---	---	40	
Wt	Weight	---	6 (0.21)	---	g (oz)

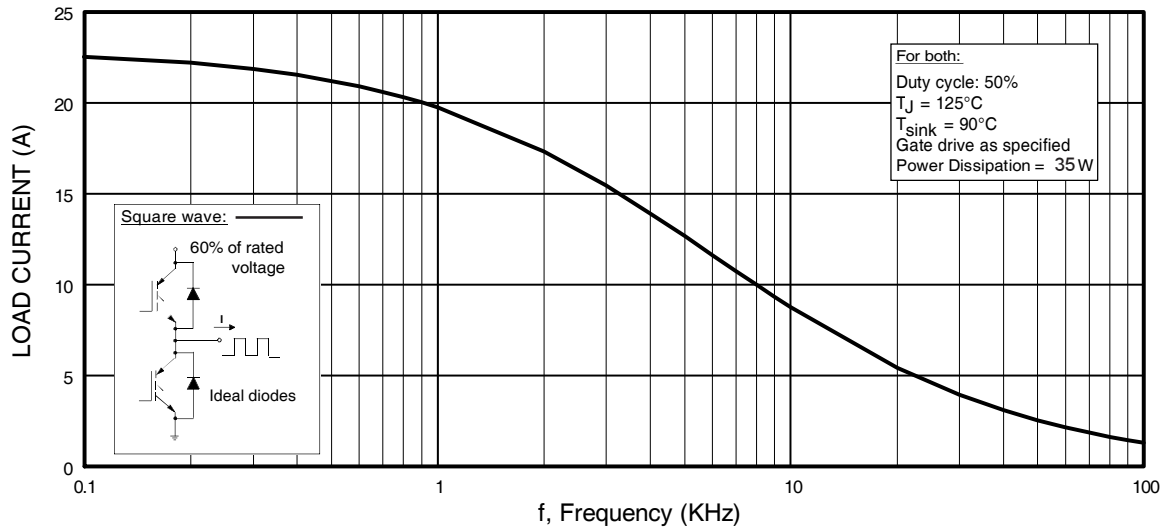
# IRG4PH40UDPbF

## Electrical Characteristics @ $T_J = 25^\circ\text{C}$ (unless otherwise specified)

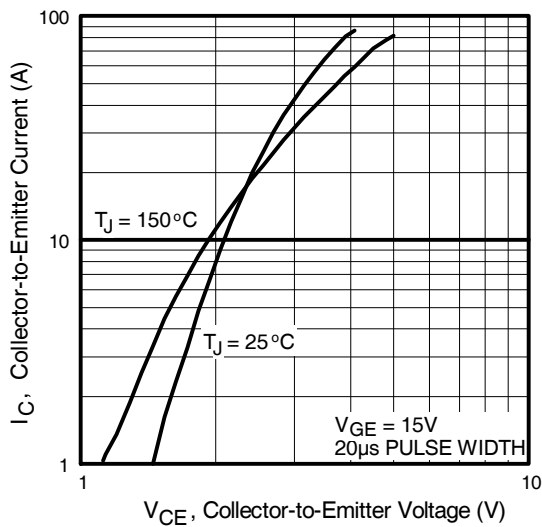
	Parameter	Min.	Typ.	Max.	Units	Conditions
$V_{(BR)CES}$	Collector-to-Emitter Breakdown Voltage <sup>③</sup>	1200	—	—	V	$V_{GE} = 0V, I_C = 250\mu A$
$\Delta V_{(BR)CES}/\Delta T_J$	Temperature Coeff. of Breakdown Voltage	—	0.43	—	V/ $^\circ\text{C}$	$V_{GE} = 0V, I_C = 1.0mA$
$V_{CE(on)}$	Collector-to-Emitter Saturation Voltage	—	2.43	3.1	V	$I_C = 21A$ $I_C = 41A$ $I_C = 21A, T_J = 150^\circ\text{C}$ $V_{GE} = 15V$ See Fig. 2, 5
		—	2.97	—		
		—	2.47	—		
$V_{GE(th)}$	Gate Threshold Voltage	3.0	—	6.0		$V_{CE} = V_{GE}, I_C = 250\mu A$
$\Delta V_{GE(th)}/\Delta T_J$	Temperature Coeff. of Threshold Voltage	—	-11	—	mV/ $^\circ\text{C}$	$V_{CE} = V_{GE}, I_C = 250\mu A$
$g_{fe}$	Forward Transconductance <sup>④</sup>	16	24	—	S	$V_{CE} = 100V, I_C = 21A$
$I_{CES}$	Zero Gate Voltage Collector Current	—	—	250	$\mu A$	$V_{GE} = 0V, V_{CE} = 1200V$
		—	—	5000		$V_{GE} = 0V, V_{CE} = 1200V, T_J = 150^\circ\text{C}$
$V_{FM}$	Diode Forward Voltage Drop	—	2.6	3.3	V	$I_C = 8.0A$ $I_C = 8.0A, T_J = 125^\circ\text{C}$ See Fig. 13
		—	2.4	3.1		
$I_{GES}$	Gate-to-Emitter Leakage Current	—	—	$\pm 100$	nA	$V_{GE} = \pm 20V$

## Switching Characteristics @ $T_J = 25^\circ\text{C}$ (unless otherwise specified)

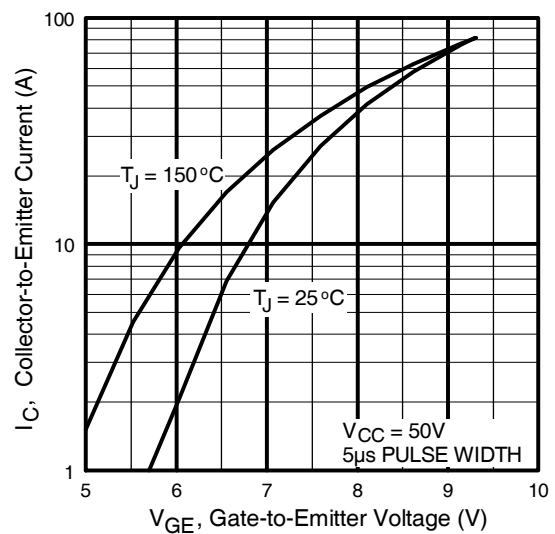
	Parameter	Min.	Typ.	Max.	Units	Conditions
$Q_g$	Total Gate Charge (turn-on)	—	86	130	nC	$I_C = 21A$ $V_{CC} = 400V$ $V_{GE} = 15V$ See Fig. 8
$Q_{ge}$	Gate - Emitter Charge (turn-on)	—	13	20		
$Q_{gc}$	Gate - Collector Charge (turn-on)	—	29	44		
$t_{d(on)}$	Turn-On Delay Time	—	46	—	ns	$T_J = 25^\circ\text{C}$ $I_C = 21A, V_{CC} = 800V$ $V_{GE} = 15V, R_G = 10\Omega$ Energy losses include "tail" and diode reverse recovery. See Fig. 9, 10, 18
$t_r$	Rise Time	—	35	—		
$t_{d(off)}$	Turn-Off Delay Time	—	97	150		
$t_f$	Fall Time	—	240	360		
$E_{on}$	Turn-On Switching Loss	—	1.80	—	mJ	$T_J = 150^\circ\text{C}$ , See Fig. 11, 18 $I_C = 21A, V_{CC} = 800V$ $V_{GE} = 15V, R_G = 10\Omega$ Energy losses include "tail" and diode reverse recovery.
$E_{off}$	Turn-Off Switching Loss	—	1.93	—		
$E_{ts}$	Total Switching Loss	—	3.73	4.6		
$t_{d(on)}$	Turn-On Delay Time	—	42	—	ns	$T_J = 150^\circ\text{C}$ , See Fig. 11, 18 $I_C = 21A, V_{CC} = 800V$ $V_{GE} = 15V, R_G = 10\Omega$ Energy losses include "tail" and diode reverse recovery.
$t_r$	Rise Time	—	32	—		
$t_{d(off)}$	Turn-Off Delay Time	—	240	—		
$t_f$	Fall Time	—	510	—		
$E_{ts}$	Total Switching Loss	—	7.04	—	mJ	
$L_E$	Internal Emitter Inductance	—	13	—	nH	Measured 5mm from package
$C_{ies}$	Input Capacitance	—	1800	—	pF	$V_{GE} = 0V$ $V_{CC} = 30V$ $f = 1.0MHz$ See Fig. 7
$C_{oes}$	Output Capacitance	—	120	—		
$C_{res}$	Reverse Transfer Capacitance	—	18	—		
$t_{rr}$	Diode Reverse Recovery Time	—	63	95	ns	$T_J = 25^\circ\text{C}$ See Fig. 14 $T_J = 125^\circ\text{C}$ 14
		—	106	160		
$I_{rr}$	Diode Peak Reverse Recovery Current	—	4.5	8.0	A	$T_J = 25^\circ\text{C}$ See Fig. 15 $T_J = 125^\circ\text{C}$ 15
		—	6.2	11		
$Q_{rr}$	Diode Reverse Recovery Charge	—	140	380	nC	$T_J = 25^\circ\text{C}$ See Fig. 16 $T_J = 125^\circ\text{C}$ 16
		—	335	880		
$di_{(rec)M}/dt$	Diode Peak Rate of Fall of Recovery During $t_b$	—	133	—	A/ $\mu s$	$T_J = 25^\circ\text{C}$ See Fig. 17 $T_J = 125^\circ\text{C}$ 17
		—	85	—		



**Fig. 1 - Typical Load Current vs. Frequency**  
 (Load Current =  $I_{\text{RMS}}$  of fundamental)



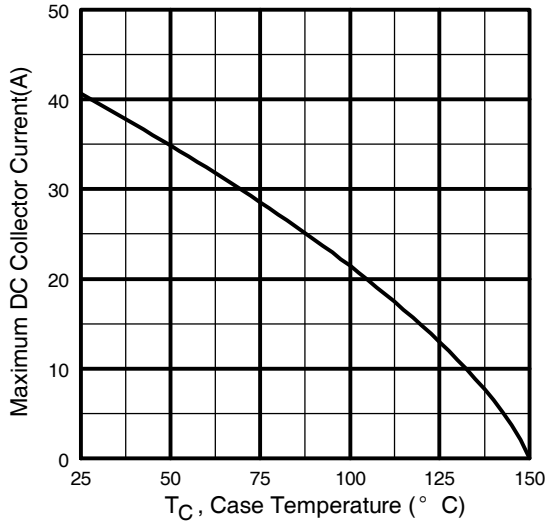
**Fig. 2 - Typical Output Characteristics**



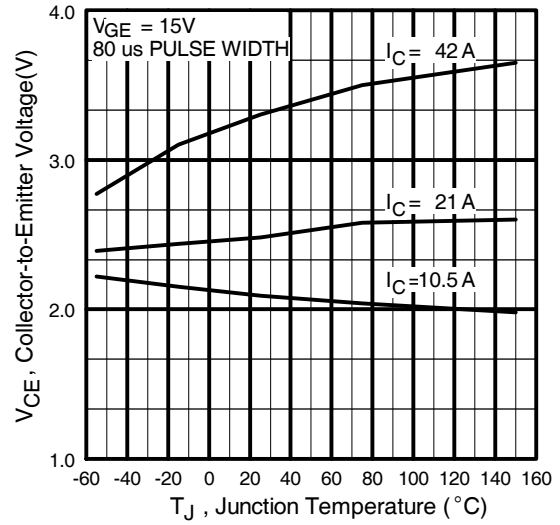
**Fig. 3 - Typical Transfer Characteristics**

# IRG4PH40UDPbF

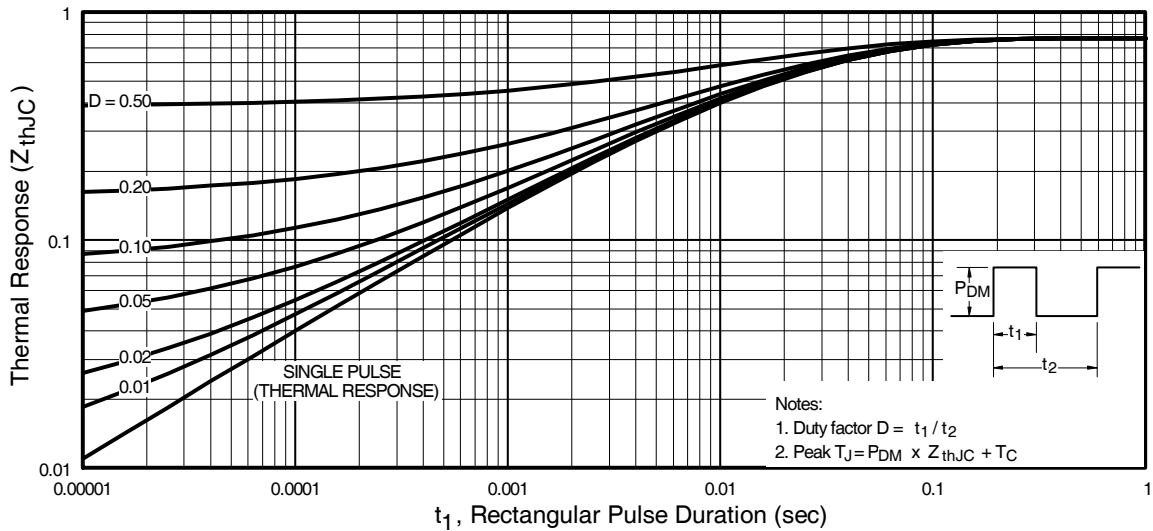
International  
**IR** Rectifier



**Fig. 4 - Maximum Collector Current vs. Case Temperature**

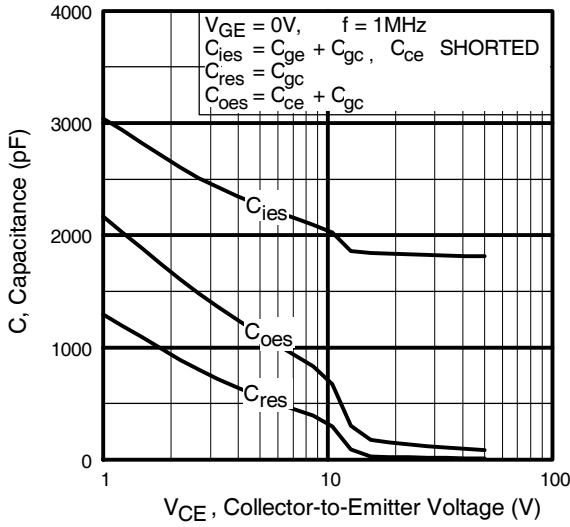


**Fig. 5 - Typical Collector-to-Emitter Voltage vs. Junction Temperature**

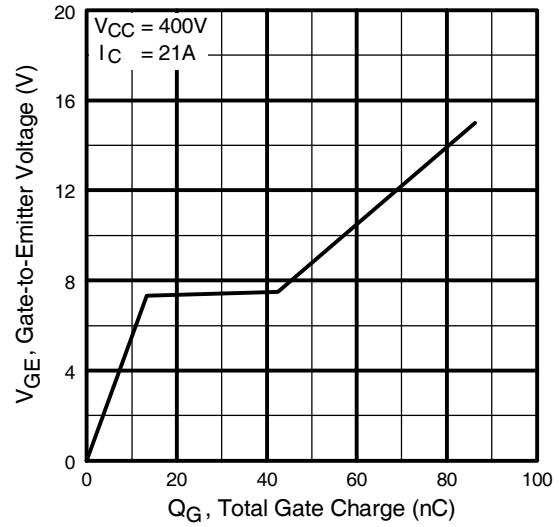


**Fig. 6 - Maximum Effective Transient Thermal Impedance, Junction-to-Case**

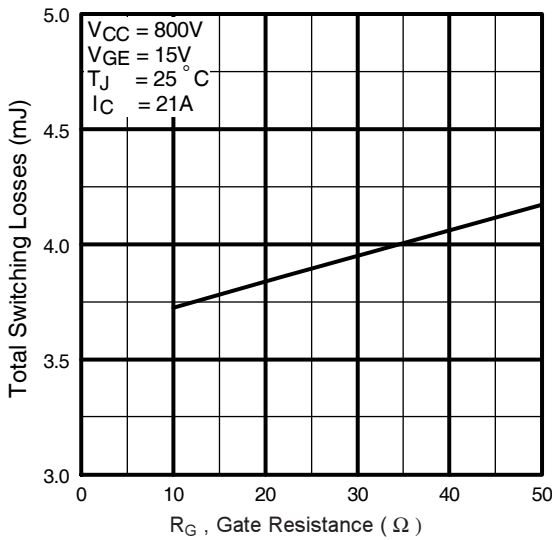
# IRG4PH40UDPbF



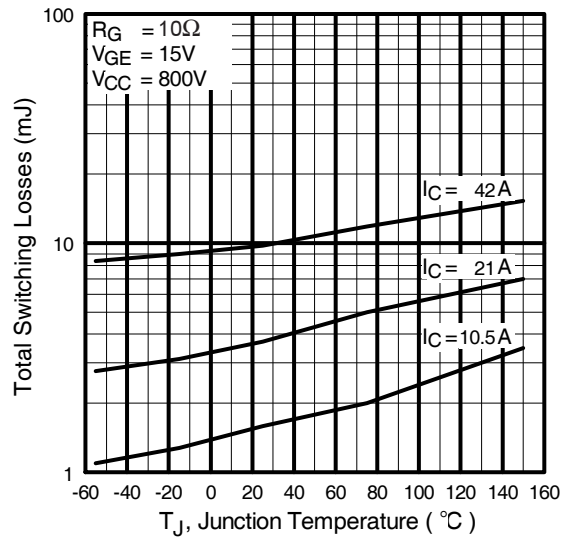
**Fig. 7 - Typical Capacitance vs. Collector-to-Emitter Voltage**



**Fig. 8 - Typical Gate Charge vs. Gate-to-Emitter Voltage**

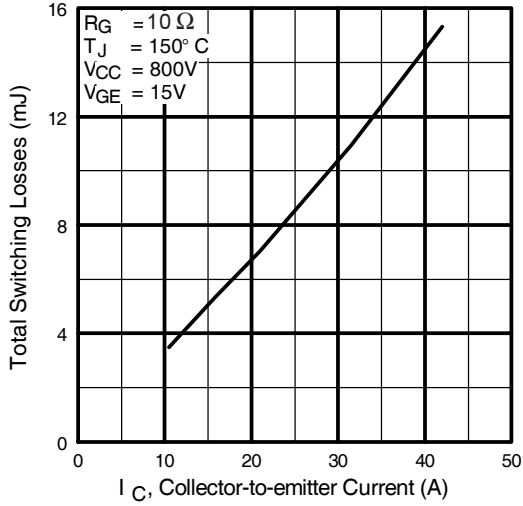


**Fig. 9 - Typical Switching Losses vs. Gate Resistance**

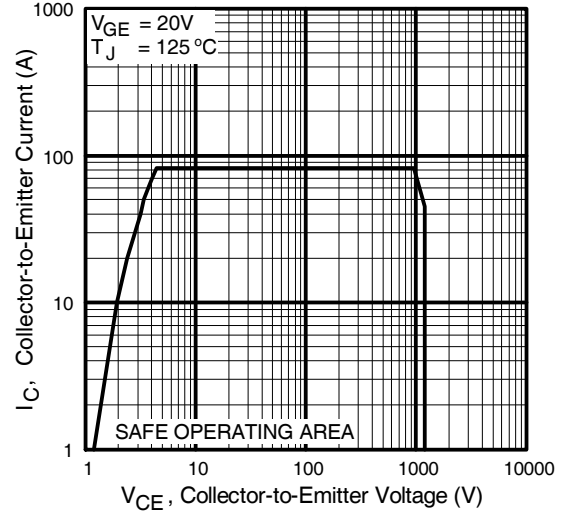


**Fig. 10 - Typical Switching Losses vs. Junction Temperature**

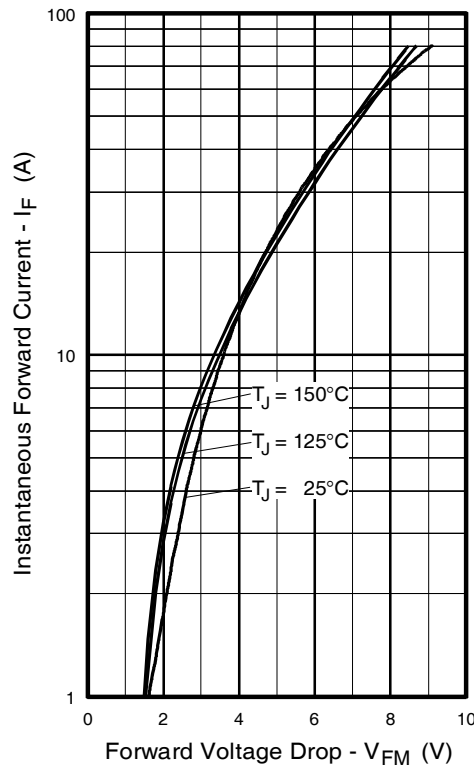
# IRG4PH40UDPbF



**Fig. 11** - Typical Switching Losses vs. Collector-to-Emitter Current



**Fig. 12** - Turn-Off SOA



**Fig. 13** - Maximum Forward Voltage Drop vs. Instantaneous Forward Current

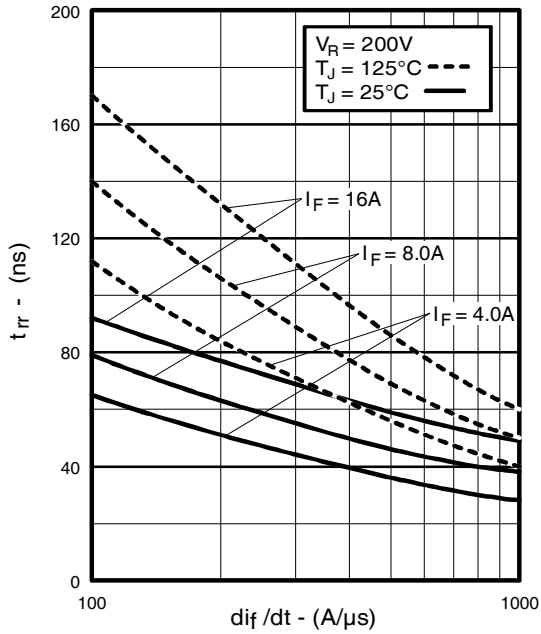


Fig. 14 - Typical Reverse Recovery vs.  $di_f/dt$

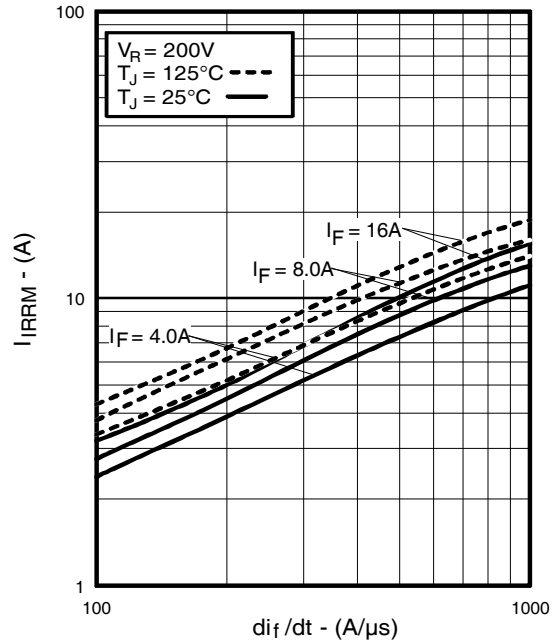


Fig. 15 - Typical Recovery Current vs.  $di_f/dt$

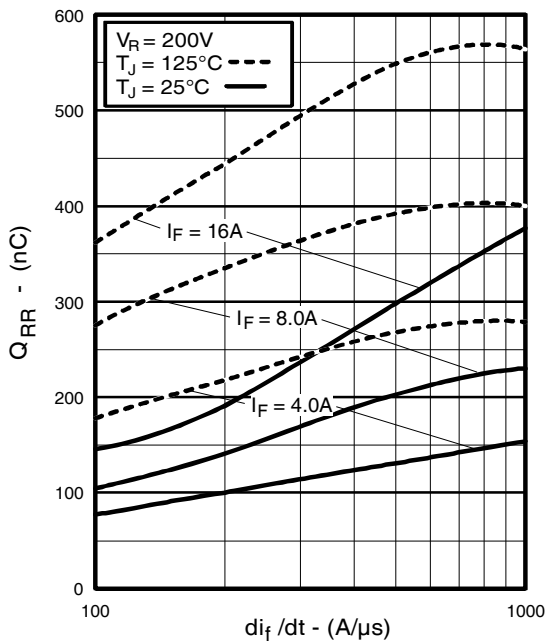


Fig. 16 - Typical Stored Charge vs.  $di_f/dt$

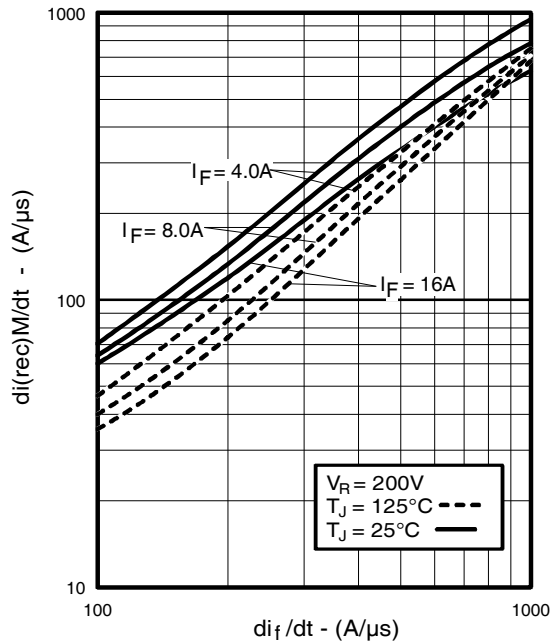
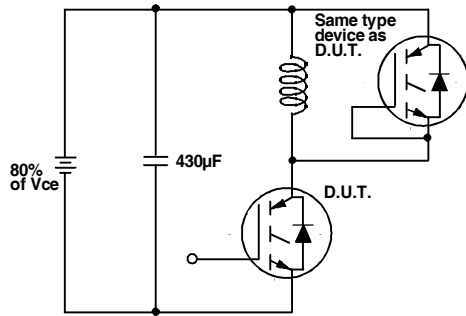
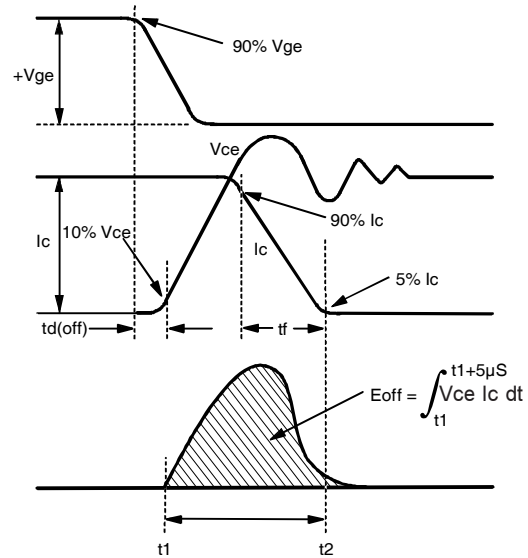


Fig. 17 - Typical  $di_{(rec)M}/dt$  vs.  $di_f/dt$

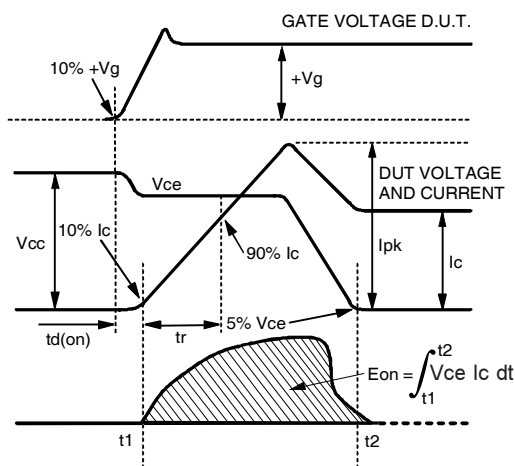
# IRG4PH40UDPbF



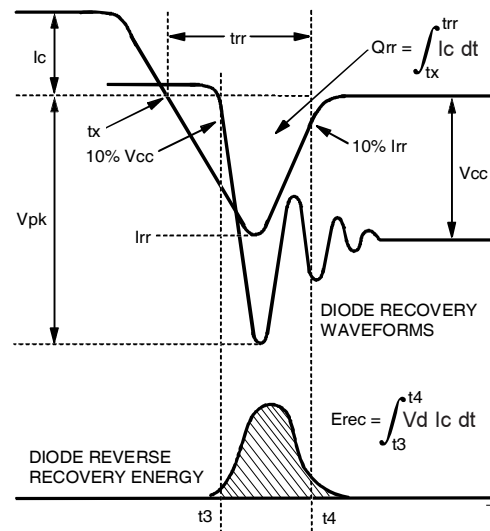
**Fig. 18a** - Test Circuit for Measurement of  $I_{LM}$ ,  $E_{on}$ ,  $E_{off}(\text{diode})$ ,  $t_{rr}$ ,  $Q_{rr}$ ,  $I_{rr}$ ,  $t_{d(on)}$ ,  $t_r$ ,  $t_{d(off)}$ ,  $t_f$



**Fig. 18b** - Test Waveforms for Circuit of Fig. 18a, Defining  $E_{off}$ ,  $t_{d(off)}$ ,  $t_f$



**Fig. 18c** - Test Waveforms for Circuit of Fig. 18a, Defining  $E_{on}$ ,  $t_{d(on)}$ ,  $t_r$



**Fig. 18d** - Test Waveforms for Circuit of Fig. 18a, Defining  $E_{rec}$ ,  $t_{rr}$ ,  $Q_{rr}$ ,  $I_{rr}$



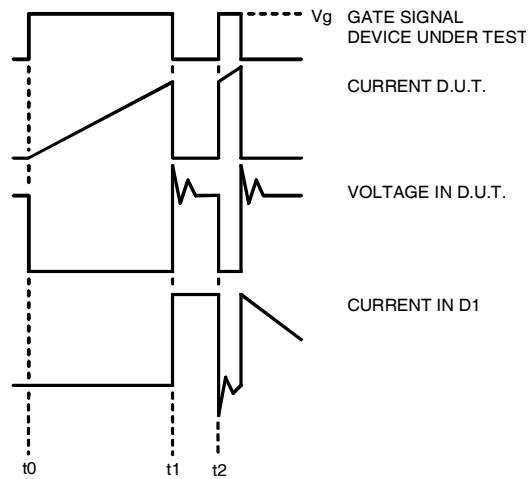


Figure 18e. Macro Waveforms for Figure 18a's Test Circuit

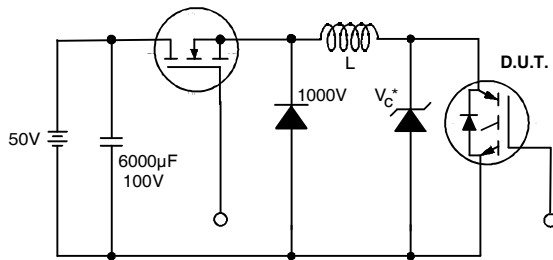


Figure 19. Clamped Inductive Load Test Circuit

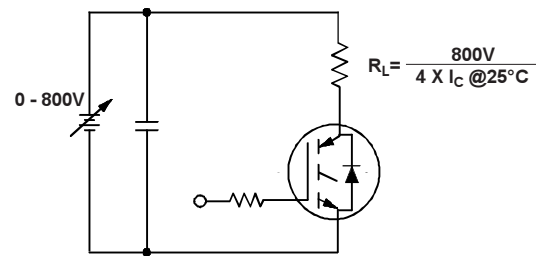


Figure 20. Pulsed Collector Current Test Circuit

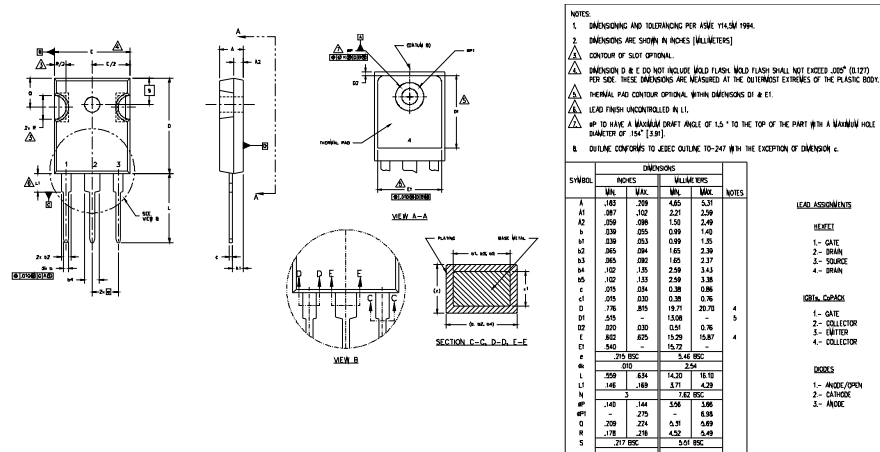
# IRG4PH40UDPbF

## Notes :

- ① Repetitive rating:  $V_{GE}=20V$ ; pulse width limited by maximum junction temperature (figure 20)
- ②  $V_{CC}=80\%(V_{CES})$ ,  $V_{GE}=20V$ ,  $L=10\mu H$ ,  $R_G=10\Omega$  (figure 19)
- ③ Pulse width  $\leq 80\mu s$ ; duty factor  $\leq 0.1\%$ .
- ④ Pulse width  $5.0\mu s$ , single shot.

## TO-247AC Package Outline

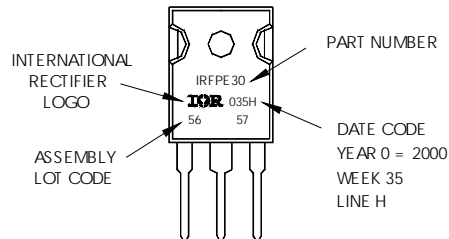
Dimensions are shown in millimeters (inches)



## TO-247AC Part Marking Information

EXAMPLE: THIS IS AN IRFP30  
WITH ASSEMBLY  
LOT CODE 5657  
ASSEMBLED ON WW 35, 2000  
IN THE ASSEMBLY LINE "H"

**Note:** "P" in assembly line position indicates "Lead-Free"



Data and specifications subject to change without notice.